

Washer extractor

WN6-35 Compass Pro



Washer featuring exceptional savings and effortless use



Priority on people

Certified ergonomic design with a human-centered approach for an outstanding user experience

Compass Pro® microprocessor offers:

- Easy program selection
- Language selection
- Quick selection and option buttons for the most frequently used wash programs and options
- Wash program packages optimized on Economy, Performance and Time



Long-term savings

Extremely low water and energy consumption – see table below

- High extraction force for efficient dewatering
- Super Balance guarantees the correct extraction force



Pure control

Monitoring of the status of the equipment and performance from anywhere, allowing to take action to improve the business

- Washers connectable to OnE Laundry, the personal assistant for hygiene validation, process management and revenue management



Global Advanced Hygiene

Global Advanced Hygiene program package* with proven log 6 reduction** disinfection of textiles through the laundry process, fulfilling the criteria of all local approved standards

Main options

- Automatic liquid detergent supply (optional I/O board)
- Connection to booking- /payment- system or coin meter



Images shown are a representation of the product only and variations may occur.

* Programs available in the standard library of all products, excluding products for specific segments where water temperature is not controllable.

** Log 6 reduction equals to 99,999% viral infectivity reduction. The efficacy of reduction of SARS-CoV-2 and other pathogens in the process is confirmed by RISE (The Research Institute of Sweden) on the basis of Electrolux Professional laboratory data.

Main specifications			WN6-35			
Max. capacity	filling factor 1:9	kg/lb	35/75			
Drum, volume		litre	330			
	diameter	ø mm	795			
Extraction		rpm	540			
G-factor			130			
Standard heating alternatives	electricity	kW	19.1 / 19.8 / 23.0			
	steam		x			
	non-heated		x			
Consumption data "ECO 60°C"			EI		Steam***	
Total time		min	Full load, 35 kg	Half load, 17.5 kg	Full load, 35 kg	Half load, 17.5 kg
Water consumption (cold+hot)		litre	51	48	51	48
Energy consumption (motor/heating/hot water)		kWh	210+57	167+36	267+0	203+0
Steam consumption		kg	0.4/1.65/3.65	0.4/1.05/2.3	0.4/-	0.4/-
Residual moisture		%	-	-	7.95	5.05
			65	74	65	74

* Water temperature 15°C cold water and 65°C hot water.

** Programs with AS.

*** Depending on steam pressure.

Electrical connections					
Heating alternative	Main voltage		Heating power kW	Total power kW	Recommended fuse A
		Hz			
Electric heated	220-230V 3 ~	50/60	19.1	20.2	63
	220-240V 3 ~	50/60	19.8/23.0	20.9/24.1	63/63
	380-400V 3/3N ~	50/60	19.1	20.2	35
	380-415V 3/3N ~	50/60	19.8/23.0	20.6/24.1	35/50
	440V 3 ~	50/60	21.0/23.0	22.2/24.1	35/35
	480V 3 ~	60	22.8/23.0	23.9/24.1	35/35
Steam or Non heated	220-415V 1/3N ~	50/60	-	1.3	10
	380-480V 3 ~	50/60	-	1.3	10

* Total power and recommended fuse does not depend on the heating power in those cases.

Water and steam connection		WN6-35
Water valves	DN	20
Water pressure	kPa	200-600
Capacity at 300 kPa	l/min	60
Drain valve	ø mm	75
Draining capacity	l/min	170
Steam valve	DN	15
Steam pressure	kPa	300-600
Liquid detergent supplies		5
Floor requirements		
Frequency of the dynamic force	Hz	7.9
Floor load at max extraction	kN	4.6 ± 5.6
Sound levels		
Sound power/pressure level at extraction*	dB(A)	72/57
Sound power/pressure level at wash*	dB(A)	67/51
Heat emission		
% of installed power, max		5
Shipping data**		
Weight	net, kg	307
Shipping volume	m ³	1.86
Accessories		
Steel base		x
Hose kits for water or steam		x
Fluff collector		x
Dimensions in mm		
A Width		910
B Depth		1115
C Height		1465
D1		505
D2		585
E		1675
F		1170
G		80
H		1365
I		345
J		245
K		1325
L		1245
M		280
N		105
O		210
P		160
1 Operating panel	7 Drain valve	
2 Door opening ø 435 mm	8 Liquid detergent supply	
3 Detergent box	9 Electrical connection	
4 Cold water	10 Steam connection	
5 Hot water		
6 Re-used water		

Front and side panels in silver grey and dark blue (color samples can be ordered on part number 472998313).

* Sound power levels measured according to ISO 60704.

** Average data. Crated weight/shipping volume depends on configuration. Please contact logistics for exact measures.

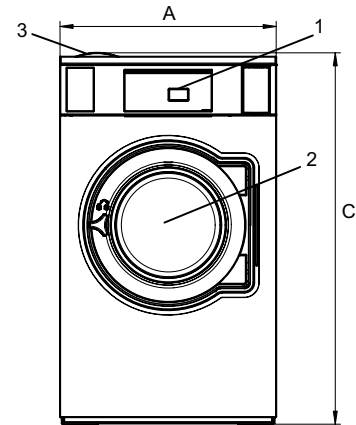

Front

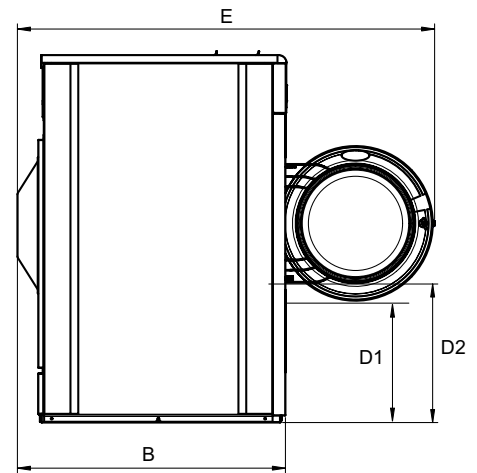

Side view

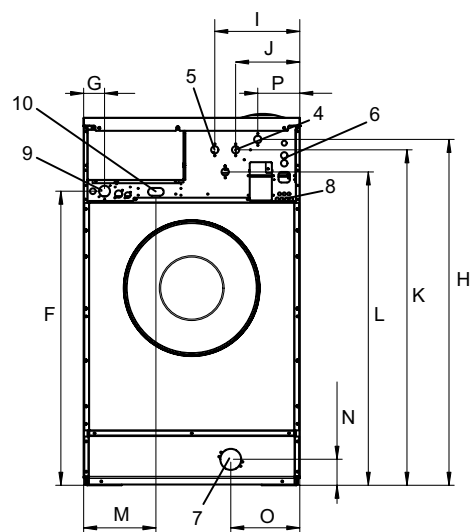

Rear